





O mobiliário do seu jeito.

Com seu detalhe marcante de recorte nos tampos das plataformas, a Linha Fit é leve e harmônica.

Com uma família completa e diversas possibilidades de combinações, ela oferece soluções de plataformas, mesas individuais e de reunião. Suas inúmeras combinações de acabamentos, composições e ajustes de medidas, permitem adequar cada projeto de forma fácil e única.

Modalidades de Atendimento



PRODUTO DE LINHA

Produtos e acabamentos
de catálogo com lead
time reduzido.



PRODUTO CONFIGURADO

Produtos de linha com
medidas especiais,
ajustadas ao projeto.



Plataforma
03



Mesas para uso individual
08



Reunião
11

Plataformas

As plataformas Fit são configuráveis e atendem inúmeras possibilidades de medidas. Além das opções de pés metálicos à escolher, a linha também conta com opção dos pés painel em MDP 25mm.

Com acabamento perfeito, as plataformas Fit são uma ótima opção para quem busca um desenho elegante e marcante.



1 - Tampo bi-partido com usinagem central.

2 - Acesso fácil e descentralizado para tomadas.

3 - Pé shaft com tamanho ideal para subida e acomodação de cabos.

4 - Fixação fácil de painéis divisores pela parte superior do tampo.

Pés Laterais

A identidade da linha pode ser facilmente customizada a partir das 3 opções de bases disponíveis.



Pés em formato trave



Pés em formato trave com perfil triangular



Pés em formato requadro



1 - Tampos

Estrutura Lateral (EL)
Recebe pé de um lado.

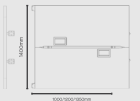

Código	Descrição
FT1034EL	1000mm
FT1034EL	1300mm
FT1034EL	1350mm

Estrutura Central (EC)
Recebe pé shaft dos dois lados.

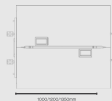

Código	Descrição
FT1034EC	1000mm
FT1034EC	1300mm
FT1034EC	1350mm

Estrutura Mista (EM)
Recebe pé shaft e pé lateral.

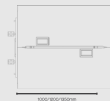

Código	Descrição
FT1034EM	1000mm
FT1034EM	1300mm
FT1034EM	1350mm

Estrutura Dupla (ED)
Recebe pé lateral dos dois lados.

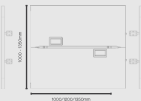

Código	Descrição
FT1034ED	1000mm
FT1034ED	1300mm
FT1034ED	1350mm

Montagem

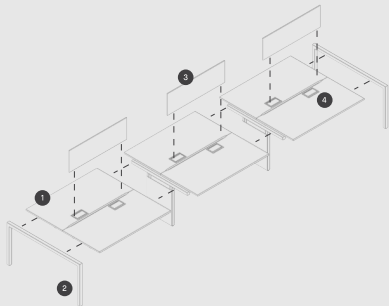

2 - Bases

Pés em formato trave 50x50
FT1034OC



Pés em formato trave 50x50
Triangular
FT1034OC



Pés em formato requadro 50x30
FT1034OC



3 - Acessórios

Panel Divisor MDP



Panel divisor suspenso em MDP 15 mm para plataforma.

Código	Descrição
FTV94DV100	1000mm
FTV94DV130	1300mm
FTV94DV135	1350mm
FTV94DV160	1600mm

Panel Divisor Vidro



Panel divisor suspenso em vidro 8 mm para plataforma.

Código	Descrição
FTV94DV100T	1000mm
FTV94DV130T	1300mm
FTV94DV135T	1350mm
FTV94DV160T	1600mm

Armário Suspenso



Armário suspenso para plataforma.

Código	Descrição
FT343OCFV	Plataforma 1000mm
FT343OCFV	Plataforma 1300mm
FT343OCFV	Plataforma 1350mm
FT343OCFV	Plataforma 1600mm

Prateleira Suspensa



Prateleira suspenso em MDP 25mm para plataforma.

Código	Descrição
FT344C100	Plataforma 1000mm
FT344C130	Plataforma 1300mm
FT344C135	Plataforma 1350mm
FT344C160	Plataforma 1600mm

Panel Divisor Lateral



Panel divisor suspenso lateral para plataforma.

Código	Descrição
FTV94DL	700mm

Suporte de CPU



Suporte de CPU fixo com regulagem

Subida de fios



Suporte de CPU giratório com regulagem

Subida de fios



Subida de Fios para plataforma frente e verso

4 - Eletrificação



Leito de Tomadas

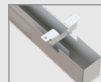

Calhas



1 - Tampos

Estrutura Lateral (EL)
Recebe pé de um lado.



Código	Descrição
FT1207EL	1000mm
FT1207EL	1000mm
FT13507EL	1350mm

Estrutura Central (EC)
Recebe pé shift dos dois lados.



Código	Descrição
FT11007EC	1000mm
FT11207EC	1200mm
FT113507EC	1350mm

Estrutura Mista (EM)
Recebe pé shift e lateral.



Código	Descrição
FT11007EM	1000mm
FT11207EM	1200mm
FT113507EM	1350mm

Estrutura Dupla (ED)
Recebe pé lateral dos dois lados.



Código	Descrição
FT11007ED	1000mm
FT11207ED	1200mm
FT113507ED	1350mm

Montagem

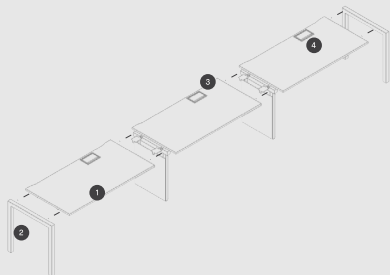

2 - Bases

Pés em formato trave 50x50

Shim: - FT17100

Esquema: - FE110004



Pés em formato trave triangular 50x50

Shim: - FT17101

Esquema: - FE110005



Pés em formato requadro 40x40

Shim: - FT17102

Esquema: - FE110006



3 - Acessórios

Armário Suspenso



Armário suspenso para plataforma.

Código	Descrição
FT3610CLL	Plataforma 1000mm
FT3610CLL	Plataforma 1200mm
FT3610CLL	Plataforma 1350mm
FT3610CLL	Plataforma 1600mm
FT3610CLL	Plataforma 1800mm

Prateleira Suspensa



Prateleira suspensa em MSP 25mm para plataforma.

Código	Descrição
FT36LC100	Plataforma 1000mm
FT36LC120	Plataforma 1200mm
FT36LC135	Plataforma 1350mm
FT36LC140	Plataforma 1400mm
FT36LC160	Plataforma 1600mm

Painel Divisor Lateral



Painel divisor suspenso lateral para plataforma.

Código	Descrição
FT36ADM	700mm

Suporte de CPU
CPUART01



Suporte de CPU fixo com regulagem.

Suporte de CPU
CPUART02



Suporte de CPU giratório com regulagem.

Subida de fios
FT36RFL0



Subida de Fios para plataforma frente e verso.

4 - Eletrificação



Leito de Tomadas

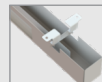

Caixas



Plataforma Dupla (Frente e Verso) Pés painel

1 - Tampos

Estrutura Lateral (EL)

Recebe pé de um lado.

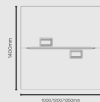

Código	Descrição
FT104EL	1000mm
FT124EL	1200mm
FT1354EL	1350mm

Estrutura Central (EC)

Recebe pé shaft dos dois lados.



Código	Descrição
FT104EC	1000mm
FT124EC	1200mm
FT1354EC	1350mm

Estrutura Mista (EM)

Recebe pé shaft e pé lateral.

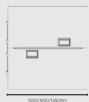

Código	Descrição
FT104EM	1000mm
FT124EM	1200mm
FT1354EM	1350mm

Estrutura Dupla (ED)

Recebe pé lateral dos dois lados.

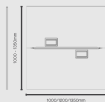

Código	Descrição
FT104ED	1000mm
FT124ED	1200mm
FT1354ED	1350mm

Montagem

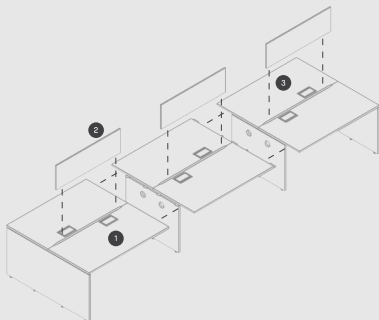

2 - Acessórios

Panel Divisor MDP



Panel divisor suspenso em MDP 15 mm para plataforma.

Código	Descrição
FTVPMV100	300mm
FTVPMV180	900mm
FTVPMV135	1050mm
FTVPMV180	1200mm
FTVPMV160	1350mm

Panel Divisor Vidro



Panel divisor suspenso em vidro 8 mm para plataforma.

Código	Descrição
FTVPMV100T	FTVPMV100U
FTVPMV180T	FTVPMV180U
FTVPMV135T	FTVPMV135U
FTVPMV180T	FTVPMV180U
FTVPMV160T	FTVPMV160U

Armário Suspenso



Armário suspenso para plataforma.

Código	Descrição
FT1310FV	Plataforma 1000mm
FT1312FV	Plataforma 1200mm
FT13135FV	Plataforma 1350mm
FT13140FV	Plataforma 1400mm
FT13150FV	Plataforma 1600mm

Prateleira Suspenso



Prateleira suspenso em MDP 25mm para plataforma.

Código	Descrição
FTB4.C100	Plataforma 1000mm
FTB4.C180	Plataforma 1200mm
FTB4.C135	Plataforma 1350mm
FTB4.C140	Plataforma 1400mm
FTB4.C160	Plataforma 1600mm

Panel Divisor Lateral



Panel divisor suspenso lateral para plataforma.

Código	Descrição
FTVPMV1	700mm

Suporte de CPU cruzeiro



Suporte de CPU fio com regulagem

Subida de fios cruzeiro



Suporte de CPU gratuito com regulagem

Subida de fios FTU04.5



Subida de Fios para plataforma frente e verso

3 - Eletrificação



Letto de Tomadas



Caixas



Plataforma Simples (Lado a Lado) Pés painel

1 - Tampos

Estrutura Lateral (EL)
Recebe pé de um lado.



Código	Descrição
FT1007EL	1000mm
FT1207EL	1200mm
FT13507EL	1350mm

Estrutura Central (EC)
Recebe pé shift dos dois lados.



Código	Descrição
FT1007EC	1000mm
FT1207EC	1200mm
FT13507EC	1350mm

Estrutura Mista (EM)
Recebe pé shift e lateral.



Código	Descrição
FT1007EM	1000mm
FT1207EM	1200mm
FT13507EM	1350mm

Estrutura Dupla (ED)
Recebe pé lateral dos dois lados.



Código	Descrição
FT1007ED	1000mm
FT1207ED	1200mm
FT13507ED	1350mm

Montagem

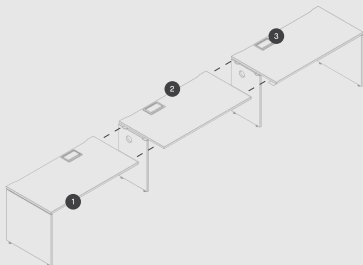

2 - Acessórios

Armário Suspenso



Armário suspenso para plataforma.

Código	Descrição
FT3010CL	Plataforma 1000mm
FT3012CL	Plataforma 1200mm
FT3013CL	Plataforma 1350mm
FT3014CL	Plataforma 1400mm
FT3016CL	Plataforma 1600mm

Prateleira Suspensa



Prateleira suspensa em MDF 25mm para plataforma.

Código	Descrição
FT3MLC100	Plataforma 1000mm
FT3MLC120	Plataforma 1200mm
FT3MLC135	Plataforma 1350mm
FT3MLC140	Plataforma 1400mm
FT3MLC160	Plataforma 1600mm

Panel Divisor Lateral



Panel divisor suspenso lateral para plataforma.

Código	Descrição
FT3MDVM	700mm

Suporte de CPU



Suporte de CPU fio com regulagem.

Suporte de CPU



Suporte de CPU giratório com regulagem.

Subida de fios



Subida de Fios para plataforma frente e verso.

3 - Eletrificação



Leito de Tomadas



Caixas

Mesas de uso individual

A linha FIT possui uma grande diversidade de medidas com elementos personalizáveis, que possibilitam a criação de postos de trabalho funcionais, com diferentes níveis de privacidade e conforto.





Mesa Retangular de trabalho pés painel

1 - Tamos

2 - Bases

Tamos Mesa Retangular



Modelo	Descrição
MRF1080	800mm
MRF1100	1000mm
MRF1120	1200mm
MRF1135	1350mm

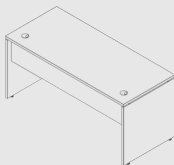

Mesa delta de trabalho pés painel

1 - Tamos

2 - Bases

Tamos Mesa Delta

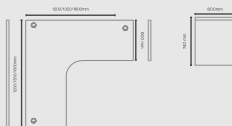

L 1200mm		L 1350mm		L 1400mm		L 1600mm	
Modelo	Descrição	Modelo	Descrição	Modelo	Descrição	Modelo	Descrição
FT1212	prof. 1200mm	FT13580	prof. 1200mm	FT1415	prof. 1500mm	FT1612	prof. 1200mm
FT1213	prof. 1300mm	FT13530	prof. 1300mm	FT1416	prof. 1600mm	FT1613	prof. 1300mm
FT12135	prof. 1350mm	FT13535	prof. 1350mm	-	-	FT1614	prof. 1400mm
FT1215	prof. 1500mm	-	-	-	-	FT1615	prof. 1500mm
FT1216	prof. 1600mm	-	-	-	-	FT1616	prof. 1600mm

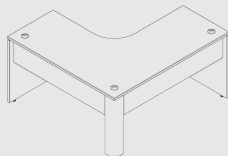

Mesa complemento delta de trabalho pés painel

1 - Tamos

2 - Bases

Tamos Mesa complemento



Modelo	Descrição
MCFT080	800mm
MCFT100	1000mm
MCFT120	1200mm
MCFT135	1350mm

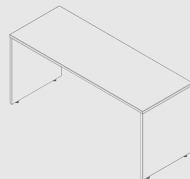



Mesa Retra de trabalho pés painel

1 - Tamos

2 - Bases

Tamos Mesa Retra



Modelo	Descrição
MRF7080	800mm
MRF7100	1000mm
MRF7120	1200mm
MRF7135	1350mm

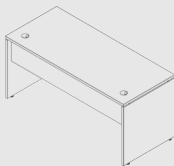

Mesa delta pés painel

1 - Tamos

2 - Bases

Tamos Mesa Delta

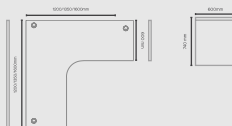

L 1200mm		L 1350mm		L 1500mm		L 1600mm	
Modelo	Descrição	Modelo	Descrição	Modelo	Descrição	Modelo	Descrição
FT1212	prof. 1200mm	FT135120	prof. 1200mm	FT1515	prof. 1500mm	FT1612	prof. 1200mm
FT1213	prof. 1300mm	FT135130	prof. 1300mm	FT1516	prof. 1600mm	FT1613	prof. 1300mm
FT122135	prof. 1350mm	FT13135	prof. 1350mm	-	-	FT1614	prof. 1400mm
FT1215	prof. 1500mm	-	-	-	-	FT1615	prof. 1600mm
FT1216	prof. 1600mm	-	-	-	-	FT1616	prof. 1600mm

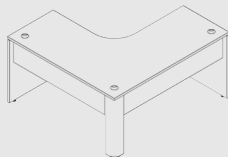

Mesa complemento delta pés painel

1 - Tamos

2 - Bases

Tamos Mesa complemento



Modelo	Descrição
MCFT080	800mm
MCFT100	1000mm
MCFT120	1200mm
MCFT135	1350mm

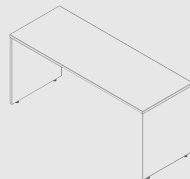

Reunião

As mesas de reunião FIT têm design elegante e minimalista. São 03 modelos de pés metálicos e tampos em formato quadrado, retangular e semioval, com diversas possibilidades de modulações e medidas.





Quadradas - Profundidade 1000mm

Tempo Mesa Reunião Quadrada

Composto por tempo superior em MDP25MM, longarinas com sistema de fixação no pé lateral, caixa tomada tamanho grande e calha para suporte de fiação.



Modelo	Descrição
MREF1100	Largura de 1000mm

Acessórios

Subida de fios
PTBURE
Subida de Fios para
mesa reunião



Eletrificaçã



Leito de Tomadas Média



Leito de Tomadas Grande



Calha

Retangular - Profundidade 1000mm

Tempo Mesa Reunião Retangular

Composto por tempo superior em MDP25MM, longarinas com sistema de fixação no pé lateral, caixa tomada tamanho grande e calha para suporte de fiação.



Modelo	Descrição
MREF1200	Largura de 2000mm

Com Pé Central

Tempo Mesa Reunião Retangular

Composto por tempo superior em MDP25MM, longarinas com sistema de fixação no pé lateral, caixa tomada tamanho grande e calha para suporte de fiação.

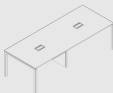

Modelo	Descrição
MREF1250	Largura de 2500mm

Semi-Oval - Profundidade 1300mm
saldada com profundidade 1000mm

Tempo Mesa Reunião Semi-Oval

Composto por tempo superior em MDP25MM, longarinas com sistema de fixação no pé lateral, caixa tomada tamanho grande e calha para suporte de fiação.



Modelo	Descrição
MREF1200S	Largura de 2000mm

Com Pé Central

Tempo Mesa Reunião Semi-Oval

Composto por tempo superior em MDP25MM, longarinas com sistema de fixação no pé lateral, caixa tomada tamanho grande e calha para suporte de fiação.



Modelo	Descrição
MREF1250S	Largura de 2500mm

Bases

Estrutura lateral em tubo
50 x 50 formato trave.



Estrutura lateral em tubo
50 x 50 formato trave triangular.

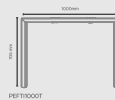

Estrutura lateral em tubo
50 x 30 formato requadro.

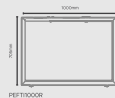



Acabamentos



Acabamento MDP,
Vidro ou Tecido

MDP/Melaminas

Acabamentos
Metálicos

MDP/Melaminas

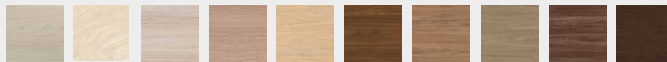

Noce Mare Compensado Carvalho Berlín Carvalho Avelã Carvalho Prata Nogueira Calena Carvalho Hanover Nogueira Thar Carvalho Munique Tabaco

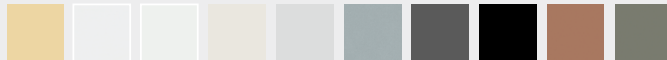

Ovo Branco Diamante Branco Ártico Argila Platina Cinza Matrix Grafite Preto CeraMik Verti

Acabamentos Metálicos



Ovo Dore Sessocita Oliva Preto Platina Prata Grafite Branco Argila

Tecidos



Bege Concept Cod.: 11311 Laranja Concept Cod.: 11305 Verde Concept Cod.: 11352 Azul Concept Cod.: 11345 Cinza Concept Cod.: 11315 Vermelho Concept Cod.: 6122 Vermelho Cod.: 6145 Azul Cod.: 2667 Laranja Cod.: 6174 Verde Cod.: 6452



Azul Claro Cod.: 1210 Preto Cod.: 2604 Cinza Cod.: 6450 Vinho Cod.: 2605 Azul Escuro Cod.: 6443

Vidros



Incolor Jateado Amarelo Vermelho Verde Azul



officerios
soluções corporativas

✉ sorocaba@officerios.com.br

📞 (15) 9 8180 0180

☎ (15) 3232 3203